



Module 4

Pure substances and
Steam tables and ideal
and real gases



Properties Of Gases

- In thermodynamics we distinguish between
 - a) perfect gases
 - b) Ideal gases
 - c) real gases
- The equation $pV/T = \text{constant}$ was derived assuming that
 - Molecules of a gas are point masses
- There are no attractive nor repulsive forces between the molecules
- Perfect gas is one which obeys the above equation.



Perfect Gas(contd...)

- Various forms of writing perfect gas equation of state
- $pV = mR_u T / M$ (p in Pa; V in m^3 ; m in kg; T in K; M kg/kmol)
- $pv = RT$
- $p = rRT$
- $pV = n R_u T$
- $\rho = \text{density (kg/ m}^3\text{)}$ $n = \text{number of moles}$
- $R_u = \text{Universal Gas Constant} = 8314 \text{ J/kmol K}$



Perfect Gas (Contd...)



- $R = \text{Characteristic gas constant} = R_u/M$
 J/kg K
- $N_A = \text{Avogadro's constant} = 6.022 \times 10^{26} \text{ k}$
 mol^{-1}
- $k_B = \text{Boltzmann constant} = 1.380 \times 10^{-23} \text{ J/K}$
- $R_u = N_A k_B$



Deductions

For a perfect gas a constant pv process is also a constant temperature process; ie., it is an isothermal process.

Eg 1: *Calculate the density of nitrogen at standard atmospheric condition.*

$$p=1.013 \times 10^5 \text{ Pa}, T=288.15 \text{ K}; R=8314/28 \text{ J/kg K}$$

$$\begin{aligned} \rho &= p/RT = 1.013 \times 10^5 / [288.15 \times (8314/28)] \\ &= 1.184 \text{ kg/ m}^3 \end{aligned}$$



Perfect Gas (contd...)



Eg 2: What is the volume occupied by 1 mole of nitrogen at normal atmospheric condition?

1 mole of nitrogen has $m=0.028$ kg. $p= 1.013 \times 10^5$ Pa, $T=273.15$ K, $R=8314/28$ J/kg K

$$V = mRT/p = 0.028 \times (8314/28) \times 273.15 / 1.013 \times 10^5 = 0.0224183 \text{ m}^3$$

$$\text{Alternately } V = nr_u t/p = 1 \times 8314 \times 273.15 / 1.013 \times 10^5 = 0.0224183 \text{ m}^3$$

This is the familiar rule that a mole of a gas at NTP will occupy about 22.4 litres.

Note: NTP refers to 273.15 K and STP to 288.15 K; $P=1.013 \times 10^5$ pa



Perfect Gas (contd...)

When can a gas be treated as a perfect gas?

A) At low pressures and temperatures far from critical point

B) At low densities

➤ A perfect gas has constant specific heats.

➤ An **ideal gas** is one which obeys the above equation, but whose specific heats are functions of temperature alone.



Real Gas

A real gas obviously does not obey the perfect gas equation because, the molecules have a finite size (however small it may be) and they do exert forces among each other. One of the earliest equations derived to describe the real gases is the van der Waal's equation

$$(P+a/v^2)(v-b)=RT;$$

Constant a takes care of attractive forces; B the finite volume of the molecule.



Real Gas (contd...)

- There are numerous equations of state.
- The world standard to day is the Helmholtz free energy based equation of state.
- For a real gas $pv \neq RT$;
- The quantity $pv/RT = z$ and is called the “COMPRESSIBILITY”.
- For a perfect gas always $z=1$.



Definitions

- Specific heat at constant volume $c_v = (\partial u / \partial T)_v$
- enthalpy $h = u + pv$
- Specific heat at constant pressure $c_p = (\partial h / \partial T)_p$
- u , h , c_v and c_p are all properties.
- Implies partial differentiation.
- The subscript denotes whether v or p is kept constant.



Definitions (contd...)



➤ For a perfect gas since c_p and c_v are constants and do not depend on any other property, we can write $c_v = du/dT$ and $c_p = dh/dT$

➤ Since $h = u + pv$ $dh/dT = du/dT + d(pv)/dT$ 1

➤ But $pv = RT$ for a perfect gas. Therefore, $d(pv)/dT = d(RT)/dT = R$

➤ Eq. 1 can be rewritten as $c_p = c_v + R$

➤ R is a positive quantity. Therefore, for any perfect gas $c_p > c_v$

➤ Note: **Specific heats and R have the same units J/kg K**



Alternate Definitions From Physics

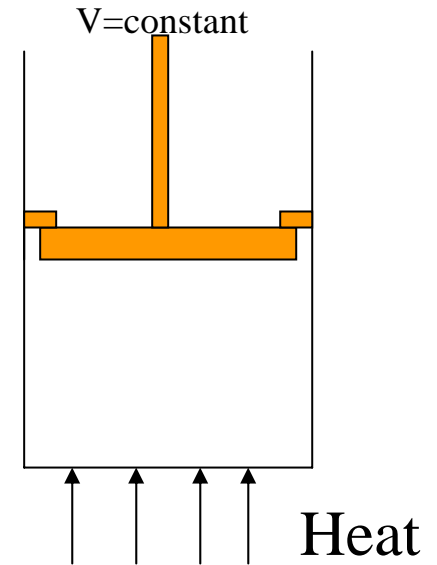
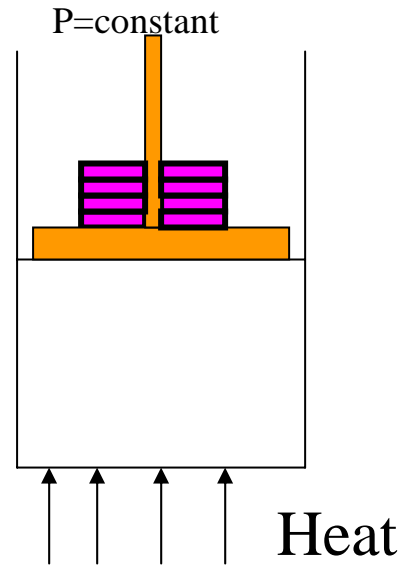
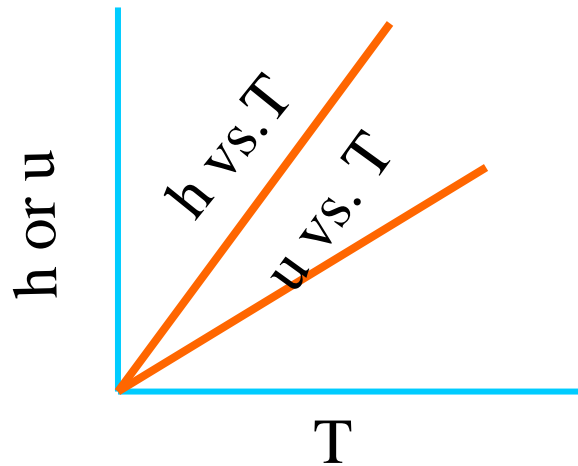



Alternate Definitions From Physics (contd...)

➤ c_p = amount of heat to be added to raise the temperature of unit mass of a substance when the pressure is kept constant

➤ c_v = amount of heat to be added to raise the temperature of unit mass of a substance when the volume is kept constant

➤ Physical interpretation of why $c_p > c_v$?



Alternate Definitions From Physics(contd...)

➤ When heat is added at const. p , a part of it goes to raising the piston (and weights) thus doing some work. Therefore, heat to be added to rise system T by $1K$ must account for this. Consequently, more heat must be added than in $v=\text{const.}$ case (where the piston does not move).



Alternate Definitions From Physics (contd...)

- When heat is added at const v the whole amount subscribes to increase in the internal energy.
- The ratio c_p/c_v is designated as γ .
- c_p and c_v increase with temperature

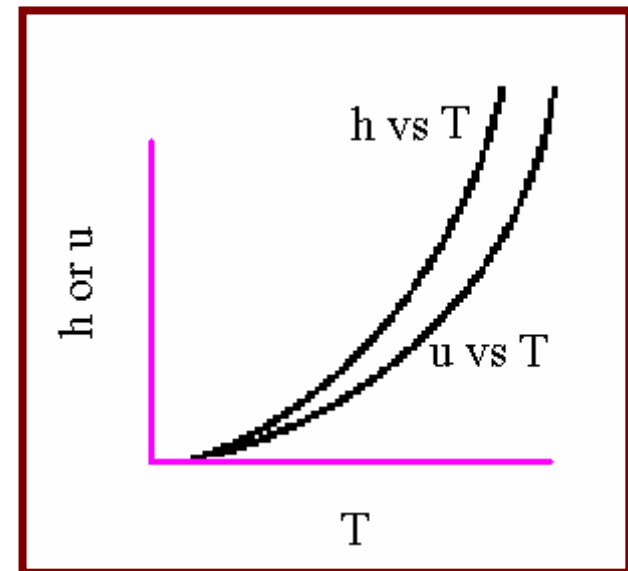



Alternate Definitions From Physics (contd...)

Volume Fractions of Components in Sea Level Dry Air
and their ratio of specific heats

		γ			γ
N ₂	0.78084	1.40	O ₂	0.209476	1.40
Ar	9.34x10 ⁻³	1.67	CO ₂	3.14x10 ⁻⁴	1.30
Ne	1.818x10 ⁻⁵	1.67	He	5.24x10 ⁻⁶	1.67
Kr	1.14x10 ⁻⁶	1.67	Xe	8.7x10 ⁻⁸	1.67
CH ₄	2x10 ⁻⁶	1.32	H ₂	5x10 ⁻⁷	1.41



Implications of an Adiabatic Process for a Perfect Gas in a Closed System



- The First Law for a closed system going through an adiabatic process is
 - $-w=du$ or $-pdv=c_vdT$ for a perfect gas
 - From the relation $c_p-c_v=R$ and $\gamma=c_p/c_v$
 - $c_v=R/(\gamma-1)$ $c_p=R \gamma /(\gamma-1)$
 - Therefore $-pdv=RdT /(\gamma-1)$ (A)
 - From the perfect gas relation $pv=RT$;



Implications (Contd...)

➤ Since During an adiabatic process p, v and T can change simultaneously let dp, dv and dT be the incremental changes.

➤ Now the perfect gas relation will be

$$(p+dp)(v+dv) = R(T+dT)$$

➤ Which on expansion become $pv + vdp + pdv + dp dv = RT + RdT$



Implications (Contd...)

➤ Using the condition $p v = R T$ and the fact that product of increments $d p d v$ can be ignored in relation to the other quantities

➤ we get

$$v dp + p dv = R dT$$

➤ Substitute for $R dT$ in eq. (A)

$$-p dv = [v dp + p dv] / (\gamma - 1)$$

➤ Rearrange terms

$$-p dv \{ 1 + 1 / (\gamma - 1) \} = v dp / (\gamma - 1)$$

➤ or $-\gamma p dv = v dp$ or $-\gamma dv/v = dp/p$



Implications (Contd...)



- We will integrate it to obtain
- $\text{const} - \gamma \ln (v) = \ln (p)$
- $\text{const} = \ln (p) + \gamma \ln (v) = \ln (p) + \ln (v^\gamma) = \ln(pv^\gamma)$
- or $pv^\gamma = \text{another constant (B)}$



Implications (Contd...)

Note: This is an idealised treatment. A rigorous treatment needs the Second Law of Thermodynamics. Eq (B) holds good when the process is also reversible. The concept of reversibility will be introduced later.

The work done during an adiabatic process between states 1-2 will be

$$W_{1-2} = (p_1 V_1 - p_2 V_2) / (g-1)$$



Implications (Contd...)



Recapitulate: $pv^\gamma = \text{constant}$

1. Is not an equation of state, but a description of the path of a specific process - adiabatic and reversible
2. Holds only for a perfect gas



Pure Substance



- Pure Substance is one with uniform and invariant chemical composition.
- Eg: Elements and chemical compounds are pure substances. (water, stainless steel)
- Mixtures are not pure substances. (eg: Humid air)



Pure Substance (contd...)



- Exception!! Air is treated as a pure substance though it is a mixture of gases.
- In a majority of cases a minimum of two properties are required to define the state of a system. The best choice is an extensive property and an intensive property



Properties Of Substance



- Gibbs Phase Rule determines what is expected to define the state of a system
- $F=C+2-P$
- F = Number of degrees of freedom (i.e., no. of properties required)
- C = Number of components P = Number of phases
- E.g.: Nitrogen gas $C=1$; $P=1$. Therefore, $F=2$



Properties of substance (Contd...)



- To determine the state of the nitrogen gas in a cylinder two properties are adequate.
- A closed vessel containing water and steam in equilibrium:
 $P=2, C=1$
- Therefore, $F=1$. If any one property is specified it is sufficient.
- A vessel containing water, ice and steam in equilibrium
- $P=3, C=1$ therefore $F=0$. The triple point is uniquely defined.



Properties of Liquids

The most common liquid is water. It has peculiar properties compared to other liquids.

- Solid phase is less dense than the liquid phase (ice floats on water)
- Water expands on cooling (a fully closed vessel filled with water will burst if it is cooled below the freezing point).
- The largest density of water near atmospheric pressure is at 4°c.



Properties of Liquids (contd...)



- The zone between the saturated liquid and the saturated vapour region is called the two phase region - where the liquid and vapour can co-exist in equilibrium.
- **Dryness fraction:** It is the mass fraction of vapour in the mixture.
- Normally designated by 'x'.
- On the **saturated liquid** line $x=0$
- On the **saturated vapour** line $x=1$
- x can have a value only between 0 and 1



Properties of Liquids (contd...)

- Data tables will list properties at the two ends of saturation.
- To calculate properties in the two-phase region:
- p, T will be the same as for saturated liquid or saturated vapour

$$v = x v_g + (1-x) v_f$$

$$h = x h_g + (1-x) h_f$$

$$u = x u_g + (1-x) u_f$$



Properties of Liquids (contd...)

- One of the important properties is the change in enthalpy of phase transition h_{fg} also called the latent heat of vaporisation or latent heat of boiling. It is equal to $h_g - h_f$.
- Similarly u_{fg} -internal energy change due to evaporation and v_{fg} - volume change due to evaporation can be defined (but used seldom).



Properties of Liquids (contd...)



➤ The saturation phase depicts some very interesting properties:

➤ The following saturation properties depict a maximum:

1. $T \rho_f$ 2. $T (\rho_f - \rho_g)$ 3. $T h_{fg}$ 4. $T_c(p_c - p)$

5. $p(T_c - T)$ 6. $p(v_g - v_f)$ 7. $T (\rho_c^2 - \rho_f \rho_g)$ 8. h_g

➤ The equation relating the pressure and temperature along the saturation is called the vapour pressure curve.

➤ Saturated liquid phase can exist only between the triple point and the critical point.



Characteristics of the critical point

1. It is the highest temperature at which the liquid and vapour phases can coexist.
 2. At the critical point h_{fg} , u_{fg} and v_{fg} are zero.
 3. Liquid vapour meniscus will disappear.
 4. Specific heat at constant pressure is infinite.
- A majority of engineering applications (eg: steam based power generation; Refrigeration, gas liquefaction) involve thermodynamic processes close to saturation.



Characteristics of the critical point (contd...)

- The simplest form of vapour pressure curve is
- $\ln p = A + B/T$ valid only near the triple point. (Called Antoine's equation)
- The general form of empirical vapour pressure curve is
- $\ln p = \ln p_c + [A_1(1 - T/T_c) + A_2(1 - T/T_c)^{1.5} + A_3(1 - T/T_c)^2 + \dots] / (T/T_c)$ (Called the Wagner's equation)
- Definitions: Reduced pressure $p_r = p/p_c$;
- Reduced temperature $T_r = T/T_c$



Characteristics of the critical point (contd...)



- For saturated phase often it enthalpy is an important property.
- Enthalpy-pressure charts are used for refrigeration cycle analysis.
- Enthalpy-entropy charts for water are used for steam cycle analysis.
- Note: Unlike pressure, volume and temperature which have specified numbers associated with it, in the case of internal energy, enthalpy (and entropy) only changes are required. Consequently, a base (or datum) is defined - as you have seen in the case of water.



Characteristics of the critical point (contd...)



- For example for NIST steam tables $u=0$ for water at triple point. (You can assign any number you like instead of 0). [Don't be surprised if two two different sets of steam tables give different values for internal energy and enthalpy].
- Since, p and v for water at triple point are known you can calculate h for water at triple point (it will not be zero).
- If you like you can also specify $h=0$ or 200 or 1000 kJ/kg at the triple point and hence calculate u .

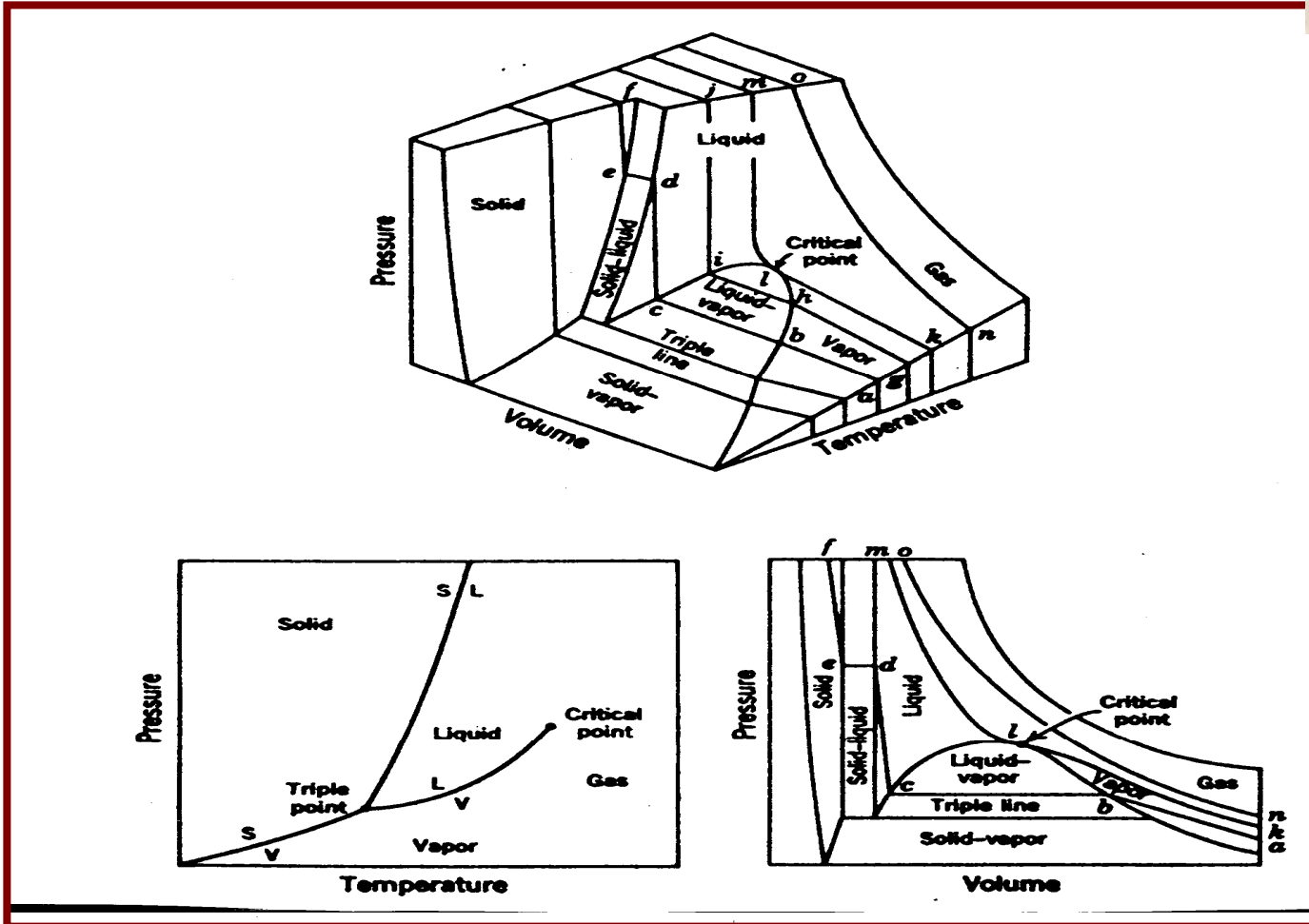

Pressure-volume-temperature surface
for a substance that contracts on freezing

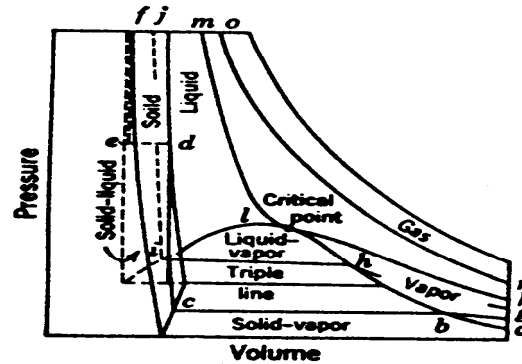
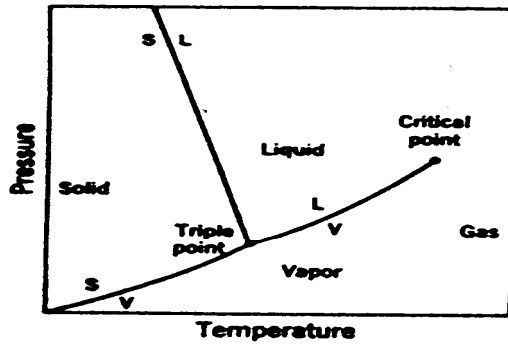
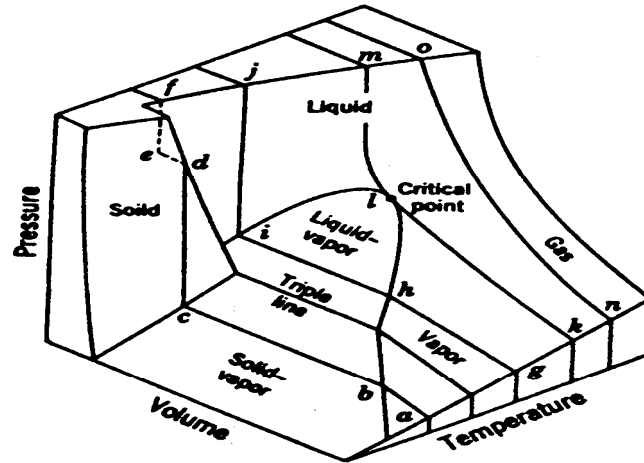

Pressure-volume-temperature surface for a substance that expands on freezing.

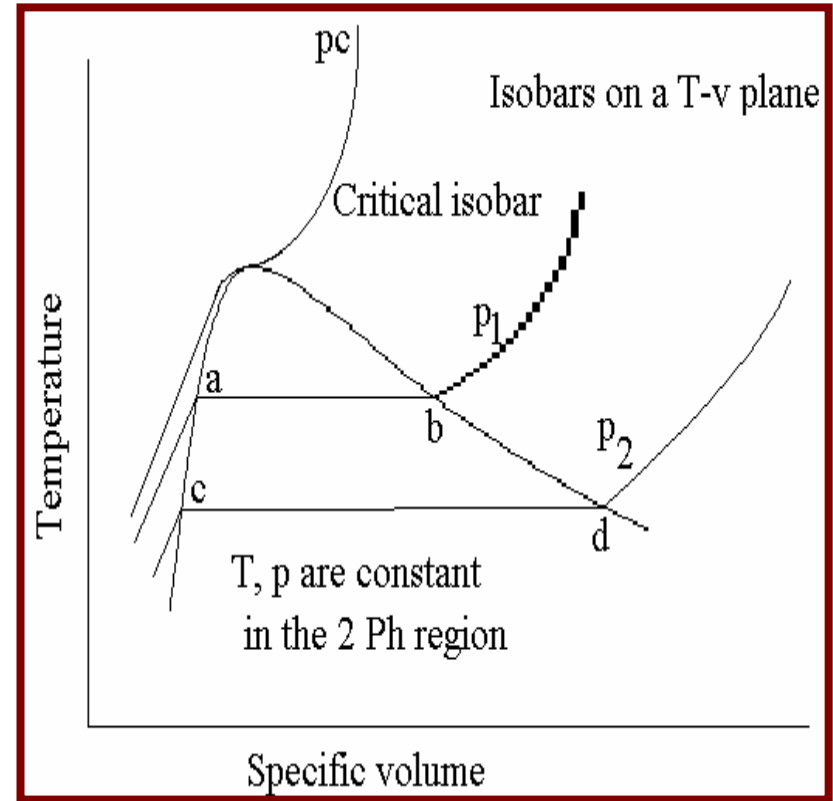
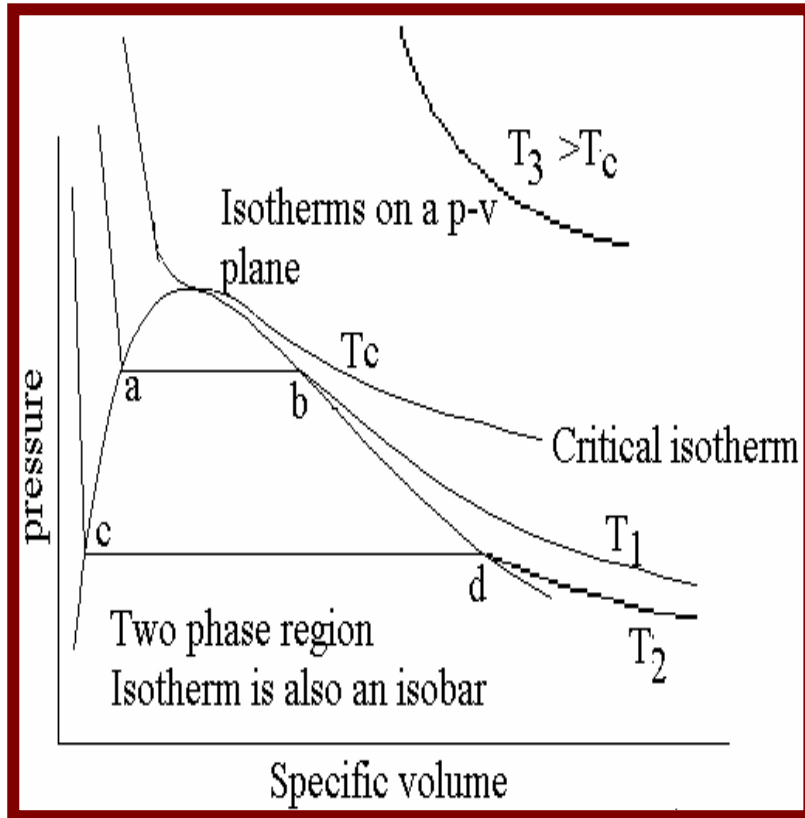

Note that there is a discontinuity at the phase boundaries
(points a,b,c,d etc.)

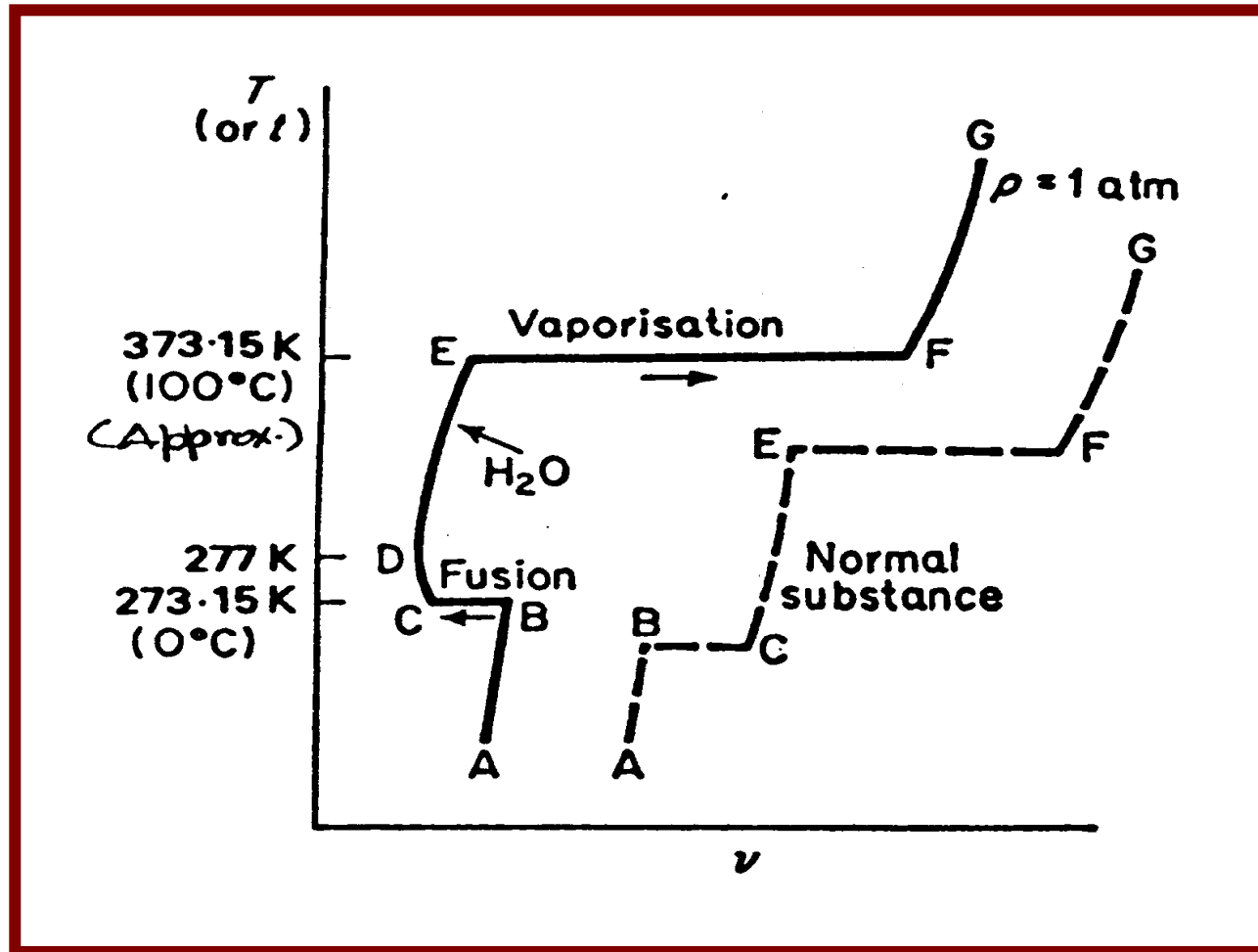

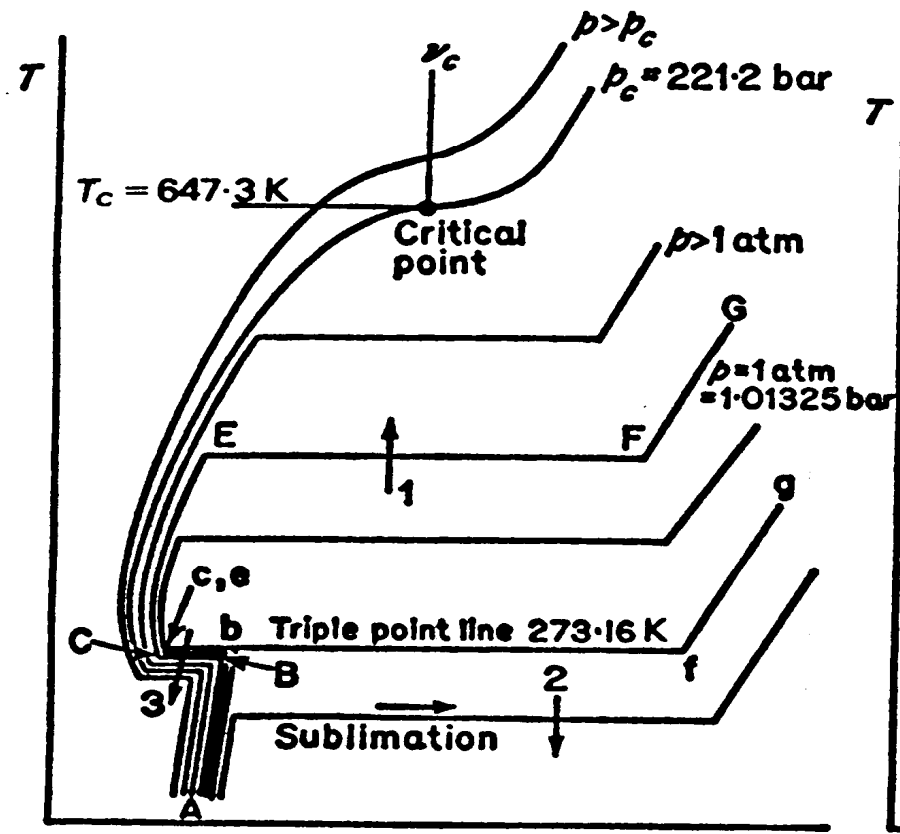

(a) Water

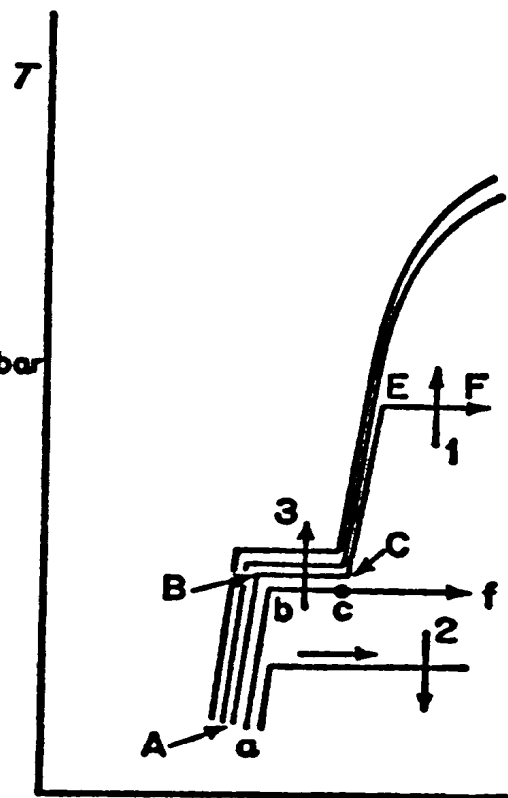

(b) Normal substance

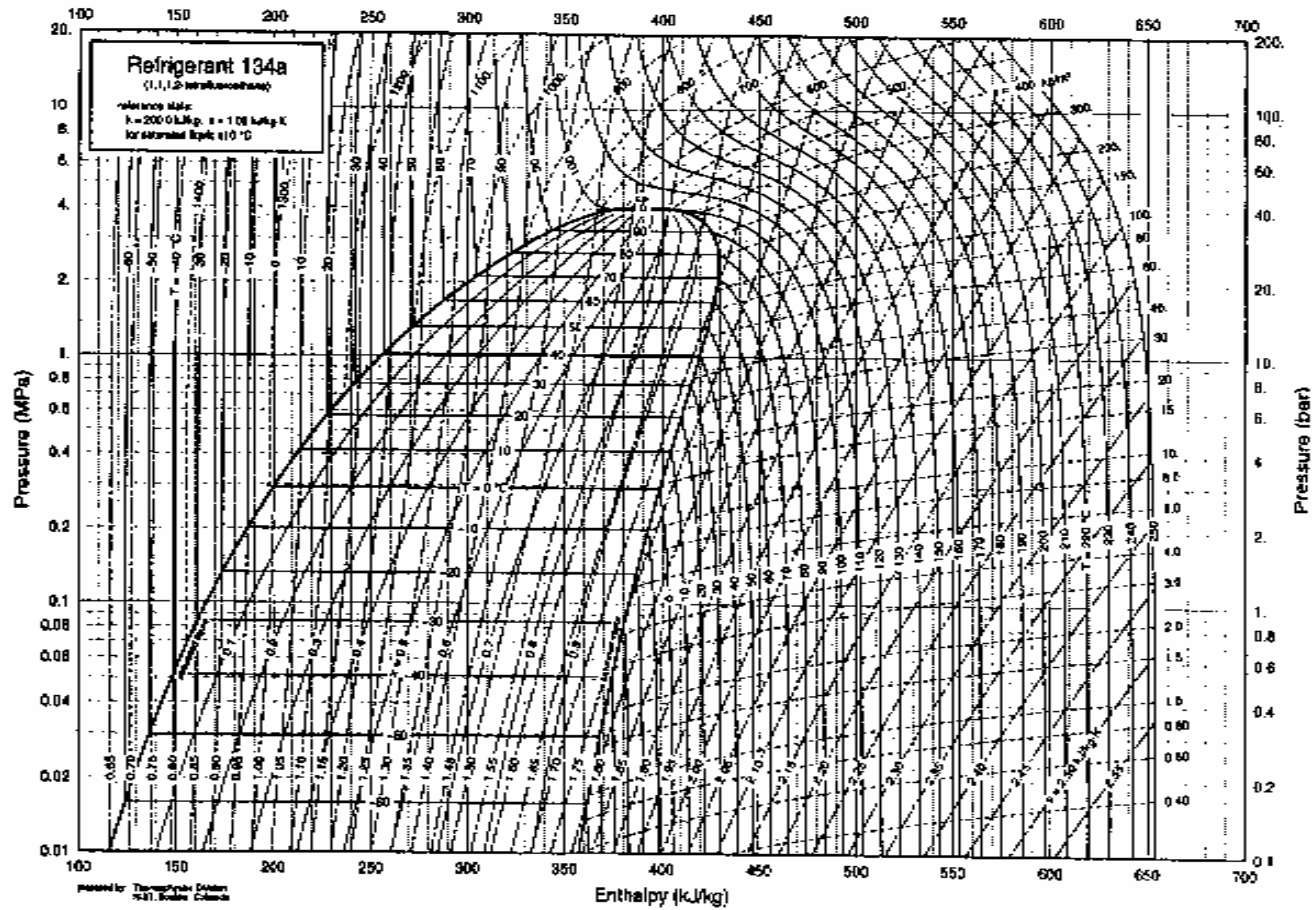



International Association for the Properties of Water and Steam (IAPWS) has provided two formulations to calculate the thermodynamic properties of ordinary water substance,

- i) “The IAPWS Formulation 1995 for the Thermodynamic Properties of Ordinary Water Substance for General and Scientific Use” (IAPWS-95) and
- ii) “The IAPWS Industrial Formulation 1997 for the Thermodynamic Properties of Water and Steam” (IAPWS-IF97).